

KINDER®
Valley

Teepee Toddler Bed

ASSEMBLY INSTRUCTIONS

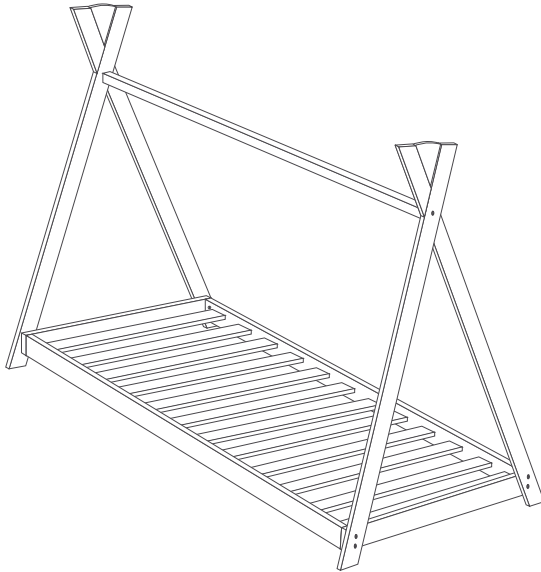

IMPORTANT! KEEP FOR FUTURE REFERENCE

Dimensions(cm): (L)150 x (W)86 x (H)145*

Fits Mattress Size(cm): (L)140 x (W)70

- Easy assembly • Safe & sturdy • Stylish teepee shape
- Can be used as a sleep space, reading nook or playhouse

*Approx. measurements only. Sizes may vary.

Contact Us...

E sales@kinder-valley.com

T 0844 7744644 - Option 2

www.kinder-valley.com



TEEPEE TODDLER BED

ASSEMBLY INSTRUCTIONS

Before you start

IMPORTANT! KEEP FOR FUTURE REFERENCE

Instructions for safe use:

WARNING - Do not place this child's bed in close proximity to heat sources, windows and other furniture e.g. open fires, radiators, gas and electric heaters etc.

WARNING - Do not use this child's bed if any part is broken, torn or missing and use only spare parts approved by Kinder Valley.

WARNING - Do not use more than one mattress.

WARNING - Regularly check the screws are secure, loose fittings can result in snagging clothes or cords posing a risk of strangulation. Assembly fittings should always be tightened properly and care should always be taken that no screws are loose to ensure your child does not trap parts of the body or clothing. Do not over tighten.

WARNING - Only use replacement parts supplied by or approved by Kinder Valley.

WARNING - Do not disassemble once the bed has been built.

This Kinder Valley toddler bed conforms to BS 8509:2008+A1:2011.

This Kinder Valley toddler bed is suitable from approximately 18 months to 4 years. It is intended to be used by one child at a time.

We recommend you use any Kinder Valley mattress size 140cm x 70cm.

Use only on firm ground which is on a horizontal level and dry.

Children are likely to play, bounce, jump and climb on beds, therefore the child's bed should not be placed too close to other furniture or windows, blind cords, curtain pulls or other strings or cords, and should be placed either tight to any wall or have a gap of 30cm between the wall and the side of the bed.

In order to clean, use only a mild detergent and warm water. Do not bleach or use any abrasive substances.

Fixtures & Fittings

CHECK THAT YOU HAVE ALL FIXTURES AND FITTINGS BEFORE ASSEMBLY, AND ENSURE THEY ARE NOT BROKEN.

A x1 Base

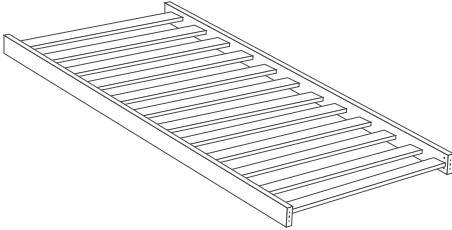

B x2 End Panels



C x4 Legs

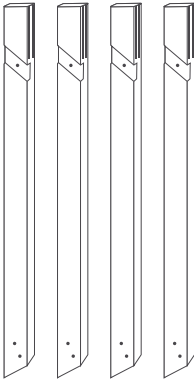

D x1 Cross Rail



E x4 Dowels



F x8 Barrel Nuts



G x2 Short Bolts (65mm)

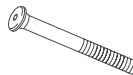

H x8 Long Bolts (105mm)

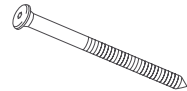

I x4 Triangles



J x1 Allen Key 1



K x1 Allen Key 2

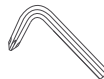

Number of people to assemble:
Two adults are required to assemble this item.



Step 1

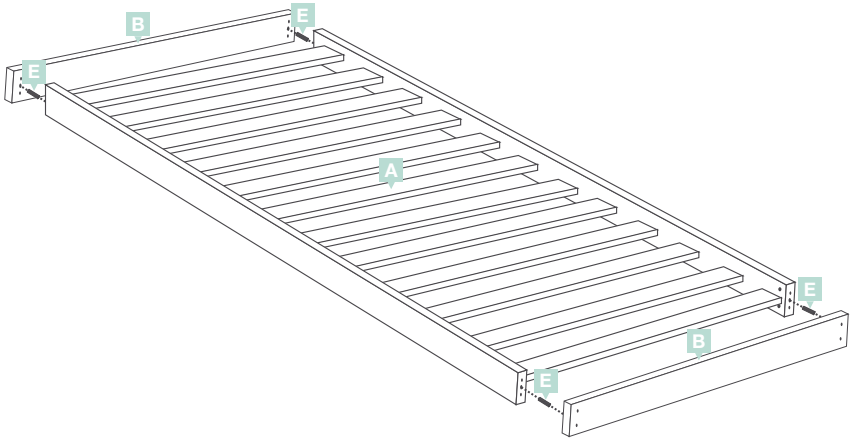

Join 2 x End Panels **B** to Base **A** with 4 x dowels **E**.

Step 2

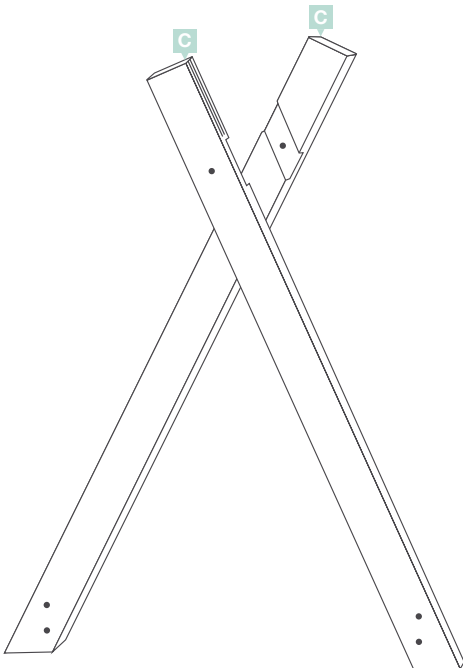

Slot 2 x Legs **C** together to form cross over ends.

Insert 2 x Triangles **I** into the top.

Repeat step with remaining 2 x Legs **C** and Triangles **I**.

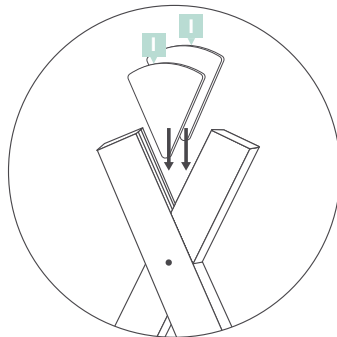

Step 3

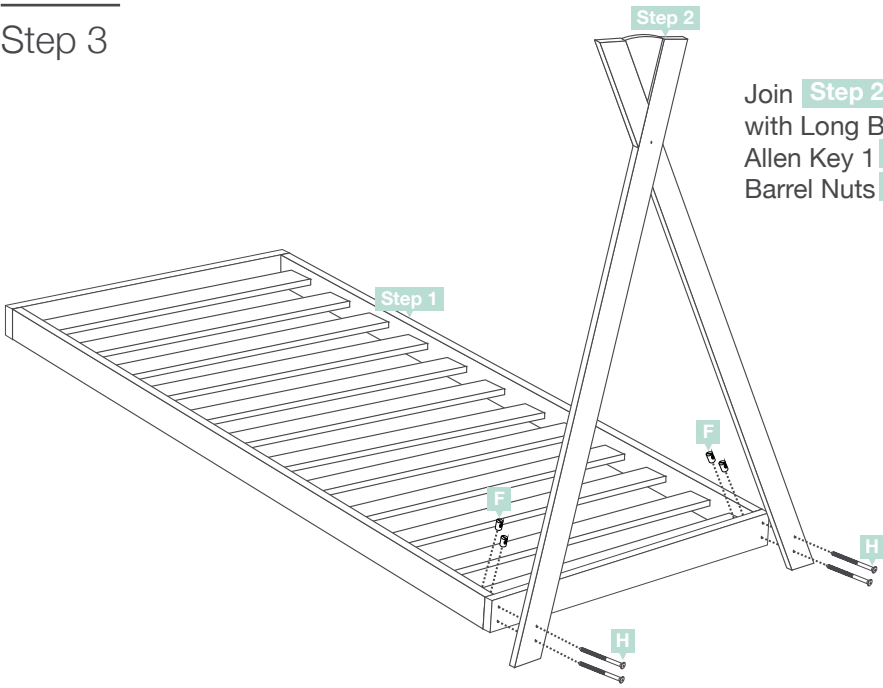

Join **Step 2** to **Step 1** with Long Bolts **H** using Allen Key 1 **J** and Barrel Nuts **F**.

Step 4

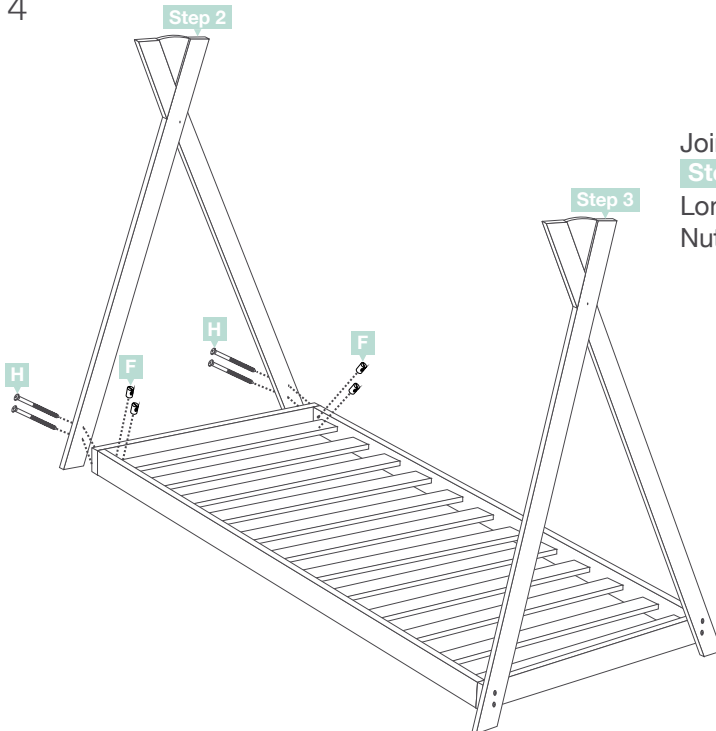

Join the remaining **Step 2** to **Step 3** using Long Bolts **H** and Barrel Nuts **F**.

Step 5

Join Cross Rail **D** to **Step 4**
with 2 x Short Bolts **G** using
Allen Key 2 **K**.

